



INDOOR/OUTDOOR
MULTIPLE

TIMER & SCORER

Operating Instructions

Model:1201772

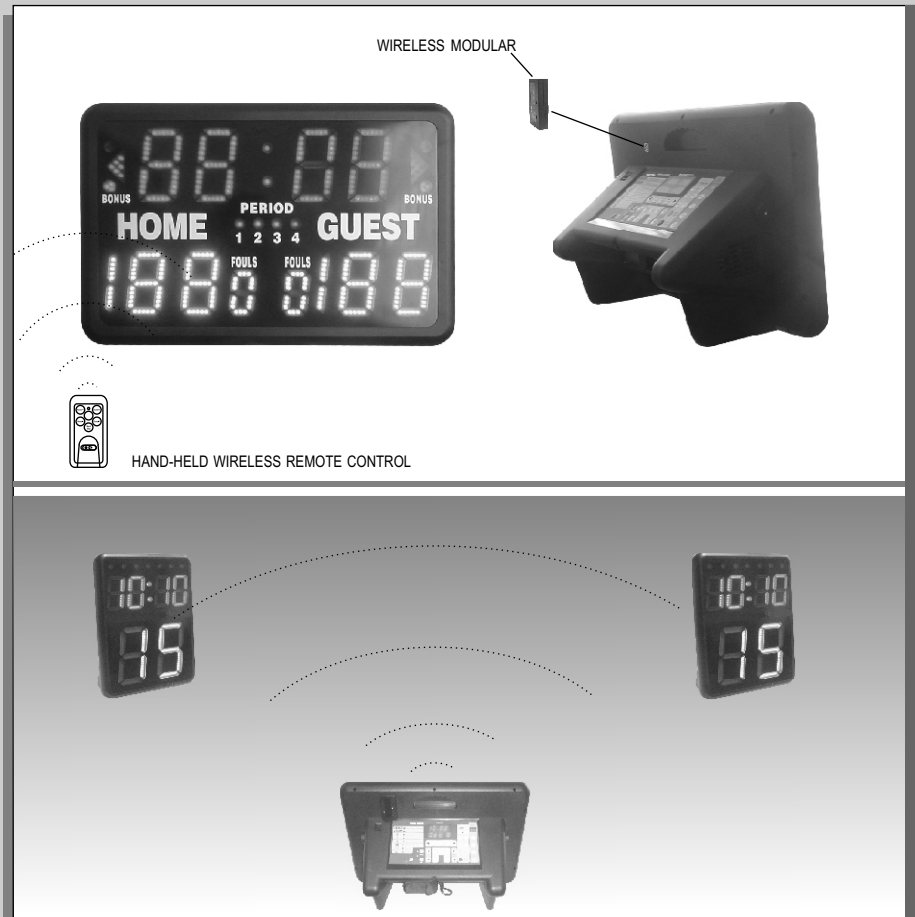

CONTROL PANEL

GAMECRAFT **TIMER & SCORER** **1201772**

1. Timer & Score/shot Clock (Basketball, Handball, Karate, Wrestling)

2. Score & Sets (Volleyball, Badminton, Table Tennis)

3. Stop Watch (Track & Field sports)

4. Match & Pin Timer (Judo)

5. Round & Count Down Timer (Boxing)

6. Electronic Metronome

7. Program Timer

8. Clock & Alarm

GAME SELECT

L
S

VOLUME

HORN

BONUS **PERIOD** **BONUS**

SCORE CLR **CHG SIDE** **FOUL CLR**

(HOME) SCORE **FOUL +1** **FOUL +1** **(GUEST) SCORE**

TIMER

CLEAR **1/10 SEC**

M+1 **S+1** **S+1**

M-1 **S-1** **S-1**

RESET TIMER **RESET SHOT CLOCK**

START /STOP **START /STOP**

SHOT CLOCK

INDEX

1.General.....	P.1
2.Power on set up.....	P.2~P.4
3.Operation Procedures	
I Game Timer & Scorer.....	P.5~P.7
IA Game Timer & Shot Clock, Scores.....	P.8~P.9
2 Score & Sets.....	P.9~P.10
3 Stopwatch.....	P.10
4 Match & Pin Timer.....	P.11
5 Round & Break Countdown Timer.....	P.12~P.13
6 Electronic Metronome	P.13
7 Program Timer	P.14
8 Clock, Alarm.....	P.15
4.Specifications.....	P.16

INDOOR/OUTDOOR TIMER & SCORER

1. GENERAL

The 1201772 timer & scorer is designed as:

- User friendly, plug & play, easy to use.
- Built-in control panel on the back, large display in the front.
Viewing distance: within 165 Feet(H), Upper Numbers:
4. 72 Inches(H), Lower numbers: 4. 33 Inches(H)
- Indoor/Outdoor brightness control function
- Multi-sport
Provide timing & scoring for various sports such as Basketball, Team handball, Wrestling, Boxing & Judo. Scoring for tennis, Badminton, Table tennis. Stopwatch for running contest.
- Clock & Alarm
When not used in sports, it can be used as digital clock with alarm function.
- Indoor Shot clock control function. (Shot clocks sold separately)
This device can work with model #1171525 shot clock. It can control the shot clock by RF wireless or data cable. Wireless modular #1171549 is sold separately for wireless operation.
- Hand-held wireless remote control
To control start/stop and score function by remote with max range of 100 Feet.
- Internal rechargeable battery
Can operate for 4 hours after fully charged. It takes 16 hours to fully charge a new battery. **The battery will charge only when the scoreboard is turned on.**
- Battery low indication
The front display will flash for 1 minute when battery is low.
User can plug in AC adaptor to resume the operation and front display will return to normal.
(Battery low indication can maintain for 15 minute)
- Compact design
Rugged construction, built-in handles, reliable solid-state electronics.

INDOOR/OUTDOOR TIMER & SCORER

2. POWER ON SET UP

To supply power to the scoreboard:

1. Plug the appropriate end of the supplied DC wall transformer into the power receptacle on the back of the scoreboard. See Figure 2-1 below.
2. Plug the wall transformer into a standard 120-volt AC outlet. See Figure 2-1 below.
3. The internal rechargeable battery will be automatically charged when power switch is turned on. It takes 16 hours to fully charge a new battery.

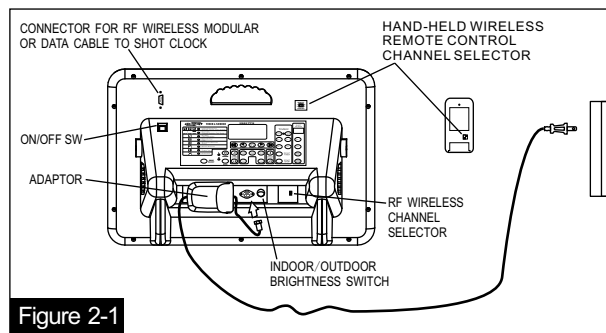

Figure 2-1

Turn on the switch on the rear panel, and the display will show: factory set up data after a few seconds

20:00 30
0000 (Real control panel)

20:00
0000 (Front display)

The display data will show last updated information if the game timer memory has been changed.

1. Press "GAME SELECT" button to choose the desired function.
2. The first game can be selected is basketball with shot clock display. Total 8 game types may be selected.
3. When time is up, the whistle will sound loud, soft or silent depending on the "VOLUME" adjusted.
4. Press "HORN" button for loud or soft sound, used as manual whistle.
5. Press "CHG SIDE" button to swap scores.
6. Press "◀" or "▶" to show the possession arrow.
7. Press "1/10 SEC" button (when LED is lit) to change the final minute to be displayed in second: 1/10 second format for game type 1.
It will show double play possession for game 2 (Score & Set) when lit.

INDOOR/OUTDOOR TIMER & SCORER

SET UP SHOT CLOCK WITH WIRELESS MODULE

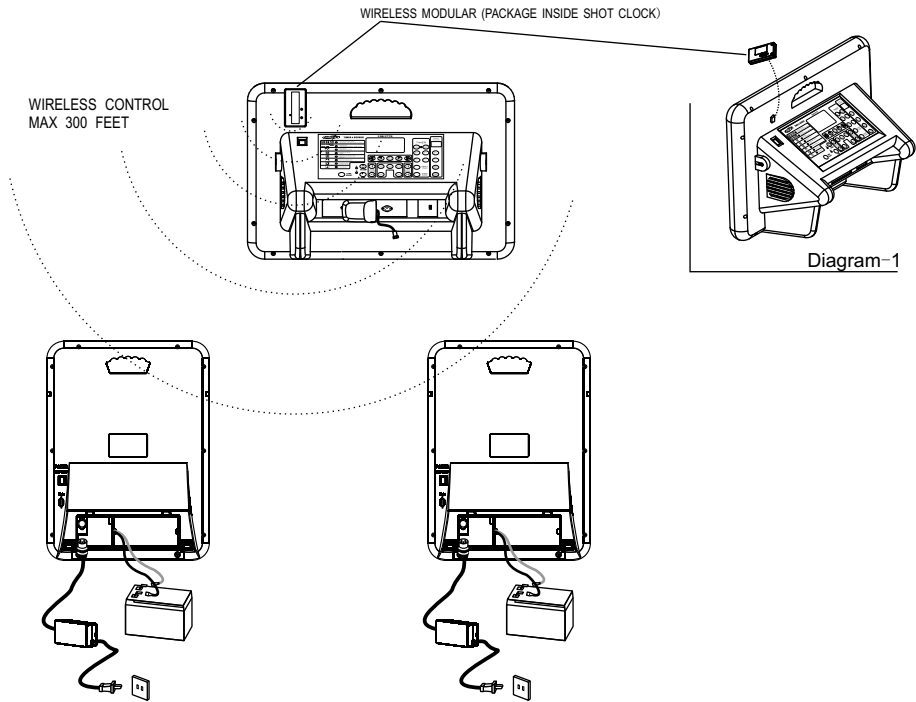

WIRELESS CONNECTION

1. The shot clock with internal wireless modular will automatically operate when the power switch is turned on. The wireless function will be shut down by when data cable socket is plugged in and changed to cable connection mode.
2. Refer to above diagram-1 to plug the wireless modular into the scoreboard and fasten it by screw driver.
3. Select and match the same channel with shot clock. Be sure to turn off the power when changing channel.

Freq, channel selection	channel	FREQ
O <input type="checkbox"/> 1 N <input type="checkbox"/> 2	A	915MHz
O <input type="checkbox"/> 1 N <input type="checkbox"/> 2	B	917MHz
O <input type="checkbox"/> 1 N <input type="checkbox"/> 2	C	919MHz
O <input type="checkbox"/> 1 N <input type="checkbox"/> 2	D	921MHz

REMARK: Scoreboard will show the channel frequency (ex: display 15 means the channel frequency is 915MHz) for one second when power is turned on.

INDOOR/OUTDOOR TIMER & SCORER

4. Turn on scoreboard power and the default game time data will be sent to shot clock. This confirms the set up is correct and the shot clock can be operated. There are some games with shot clock function. Please refer to the operation procedures for detail.

5. If there is wireless interference, please turn off both shot clock and scoreboard and select other channel until no interference. If all wireless channels receive interference, please change to data cable connection.

6. The max control range is 300 feet "100 meters".

SET UP SHOT CLOCK WITH DATA CABLE CONNECT

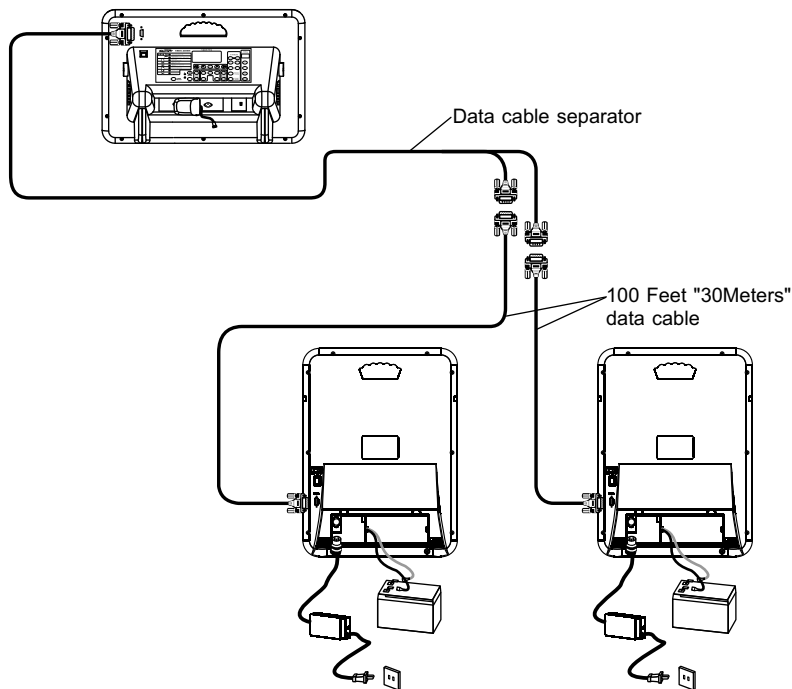

DATA CABLE CONNECTION

1. Turn off the scoreboard.
2. Remove the wireless modular from the scoreboard.
3. Connect the data cable separator into the scoreboard data cable connect position.
4. Connect the 100 Feet "30Meters" data cable into the data cable separator.
5. Turn off shot clock.
6. Connect the data cable into the shot clock data cable connect position.
7. Turn on shot clock.
8. Turn on scoreboard. The default game data will be sent to shot clock when scoreboard is turned on to confirm the data cable connection is correct.

INDOOR/OUTDOOR TIMER & SCORER

3. OPERATION PROCEDURES

1 GAME TIMER & SCORER

Displays remaining game time & score:
Upper display: Game timer (max=99:59)
Lower display: Scorer (max=199)

For use indoors with wireless shot clock control function.

Basketball
Wrestling
Karate
Team Handball

Game timer & shot clock (count down)





Operation	Key Operation		Scoreboard front display	Wireless shot clock display	Buzzer
	Timer	Shot Clock			
1. To select game function			0:00 0 0	0:00 0 0	
2. Recall last memory			20:00 0 0	20:00 3 0	
3. Erase previous setting			0:00 0 0	0:00 3 0	
			20:00 0 0	20:00 3 0	
5. Set shot clock			20:00 0 0	20:00 3 0	
6. Beginning shot clock time is memoried			19:59 0 0	19:59 2 9	
7. Set period			1234 ••••		
8. Shot hits rim			19:58 0 0	19:58 3 0	
9. Game interrupted			19:50 0 0	19:50 2 2	
10. Restart game & shot clock start simultaneously			19:49 0 0	19:49 2 1	
(1).30 seconds expires			19:28 0 0	19:28 0	buzzer) ALERT FLASH ON SHOT CLOCK
(2).Reset to 30 seconds			19:28 0 0	19:28 3 0	
(3).Restart game			19:27 0 0	19:27 2 9	
11. Game time expires (buzzer)			0:00 0 0	0:00 0 6	buzzer) ALERT FLASH ON SHOT CLOCK
12. Reset game time			20:00 0 0	20:00 3 0	

- Game timer stopped too late:
Use and keys to adjust time difference.

INDOOR/OUTDOOR TIMER & SCORER





- Press  button for loud or soft sound, used as manual whistle.



Scorer

Operation	Key	Display
	Scorer	
1. Guest team gains a point	SCORE  GUEST	19:20 0 1
2. Home team gains a point	SCORE  HOME	19:15 1 1
3. Home team gains a point	SCORE  HOME	19:15 2 1
4. Reset to 0 vs. 0		19:15 0 0

- Point added in error:
- Use score button-1 to adjust.

Foul

Operation	Key	Display
	FOUL	
1. Guest team commits foul	 GUEST	19:20 0 1
2. Home team commits foul	 HOME	19:15 1 1
3. Home team commits foul	 HOME	19:15 2 1
4. Reset		19:15 0 0

Press Possession Indicator ARROW   to change between Home or Guest possession.

Press   For Bonus indication.
Bonus Bonus

INDOOR/OUTDOOR TIMER & SCORER

Game Timer (count up)

Game timer display can be changed from displaying (count down) to the (count up) mode. Maximum setting: 99:59. In this mode the upper colon between the minutes and seconds blinks.

Shot clock display: count down (max=99seconds)

For use indoors with wireless shot clock control function

Operation	Key Operation		Scoreboard front display	Wireless shot clock display	Buzzer
	Timer	Shot clock			
1. To select game function			20:00 0 0	20:00 3 0	
2. Erase previous setting			0:00 0 0	0:00 3 0	
3. Change display to count up mode			0:00 0 0	0:00 3 0	(chirp)
4. Set game timer (ex: 20 minutes)			20:00 0 0	20:00 3 0	
5. Recall shot clock memory (shot clock setting into memory from count down procedure)			20:00 0 0	20:00 3 0	
6. Begin game-time returns to 0:00			0:00 0 0	0:00 3 0	
7. Start game time is entered into memory & shot clock start simultaneously			0:00 0 0	0:00 2 9	
8. Stop game			0:09 0 0	0:09 2 1	
9. Reset shot clock				0:09 3 0	
10. Restart game			0:10 0 0	0:10 2 9	
11. Stop shot clock display count down			0:19 0 0	0:19 2 0	
12. Game time expires			20:00 0 0	20:00 2 0	(buzzer) ALERT FLASH ON SHOT CLOCK
13. Return time to 0:00			0:00 0 0	0:00 2 0	

Game timer stopped too late:

Use and buttons to adjust time difference.

Returning to count down display:

Press the timer button, and then press the button.

INDOOR/OUTDOOR TIMER & SCORER

1A GAME TIMER & SHOT CLOCK, SCORES

Basketball

Displays remaining game time and remaining shot clock time:

Upper display: Game timer (max=99:59)

Lower display: shot clock(max=99 seconds)

For use indoors with wireless shot clock control function.

Game Timer & Shot Clock display

Operation	Key Operation		Scoreboard front display	Wireless shot clock display	Buzzer
	Timer	Shot Clock			
1. To select game function			0:00 00	0:00 0 0	
2. Recall last memory			20:00 30	20:00 3 0	
3. Erase previous setting			0:00 30	0:00 3 0	
4. Set game timer (ex: 20 minutes)			20:00 30	20:00 3 0	
5. Set shot clock			20:00 30	20:00 3 0	
6. Beginning shot clock time is memoried			19:59 29	19:59 2 9	
7. Shot hits rim			19:58 30	19:58 3 0	
8. Game interrupted			19:50 22	19:50 2 2	
9. Restart game & shot clock start simultaneously			19:49 21	19:49 2 1	
(1).30 seconds expires			19:28 00	19:28 0 0	buzzer) ALERT FLASH ON SHOT CLOCK
(2).Reset to 30 seconds			19:28 30	19:28 3 0	
(3).Restart game			19:27 29	19:27 2 9	
10. Game time expires (buzzer)			0:00 06	0:00 0 6	buzzer) ALERT FLASH ON SHOT CLOCK
11. Reset game time			20:00 30	20:00 3 0	

- Game timer stopped too late:
Use and buttons to adjust time difference.
- Press button (when LED is lit) to change the final minute to be displayed in 1/10 second on scoreboard and 1/100 second on shot clock.
- Press button for loud or soft sound, used as manual whistle.

INDOOR/OUTDOOR TIMER & SCORER

- Press score keys to change to score display at lower part.
- Press shot clock timer reset keys to change to shot clock timer display.
- The game select type LED will flash to indicate function for shot clock.

2 SCORE & SETS

Displays sets won and game score.

Upper display: Score(max=99)

Lower display: Sets(max=199)

Volleyball
Badminton
Table Tennis

Score		
Operation	Key Operation	Display
	Score	
1.Home team gains a point	SCORE (+1) HOME	1 0 0 0
2.Guest team gains a point	SCORE (+1) GUEST	1 1 0 0
3.Guest team gains a point	SCORE (+1) GUEST	1 2 0 0
4.Change courts (if desired)	(CHG SIDE)	2 1 0 0
5.Reset to 0 vs. 0	(SCORE CLR)	0 0 0 0

- Extra point added in error:
Use SCORE-1 to adjust.

Sets		
Operation	Key Operation	Display
	Sets	
1.Home team gains a point	(SET HOME)	0 0 1 0
2.Guest team gains a point	(SET GUEST)	0 0 1 1
3.Guest team gains a point	(SET GUEST)	0 0 1 2
4.Change courts (if desired)	(CHG SIDE)	0 0 2 1
5.Reset to 0 vs. 0	(SET CLR)	0 0 0 0

- Extra set added in error:
Press CLEAR SET button and add the correct number of sets.

INDOOR/OUTDOOR TIMER & SCORER

Serve/Side Out/Possession Indicator

Operation	Key Operation	Display
	Serve	
1.Home team gets service/side out	◀ HOME	◀ 1 2 3 4
2.Guest team gets service/side out	▶ GUEST	1 2 ▶ 3 4
3.Change courts (if desired)	CHG SIDE	◀ 2 1 4 3
4.Reset 0 vs. 0	SCORE CLR + SET CLR	0 0 0 0

- Press 1/10 Sec to change to double play possession indication (After 1/10 sec LED is lit, press ◀ or ▶ Indicate this status)
- Press 1/10 Sec again to change back.

3 STOPWATCH

Displays split-time stopwatch:

Upper display: Minutes: Seconds (max=59 minutes, 59 seconds)

Lower left display: Hours (max=199 hours)

Lower right display: 1/100 seconds (max=99 1/100 seconds)

Stopwatch

Operation	Key Operation	Display
	Stopwatch	
1.Start	○ START /STOP	00:00 01
2.Stop	○ START /STOP	15:24 2 93
3.Reset to 00:00	○ RESET TIMER	00:00 00

- When the timer is running, press RESET TIMER will stop display but the timer keeps running internally.
The lower left display will blink "UP" to indicate this status.
Press RESET TIMER again will show the running time again.

000

INDOOR/OUTDOOR TIMER & SCORER

4 MATCH & PIN TIMER

Judo

Displays remaining match time and elapsed pin time:

Upper display: Match timer (max=99:59)

Lower display: Pin timer (resets to 30 seconds)

Match & Pin Timer			
Operation	Key Operation		Display
	Timer	Shot Clock	
1. Set match time (ex:5 minutes)	HOLD DOWN M+1		5:00 30
2. Save pin time into memory		RESET SHOT CLOCK	5:00 0
3. Begin match-time is entered into memory (30 Seconds)	START /STOP		5:00 1
4. If pin does not begin, pause pin time first and press Reset button to reset to 0. Ready to begin pin time.		START /STOP + RESET SHOT CLOCK	4:53 0
5. Pin begins		START /STOP	4:23 1
6. Stop match during pin-pause pin timer Time Start/Stop button timer & pin timer simultaneously	START /STOP		4:35 12
7. Restart match-resume pin timer Time Start/Stop button starts both timer & pin timer simultaneously	START /STOP		4:34 13
8. Pin broken free		START /STOP	4:25 22
		START /STOP	1:31 1
(1). Next pin begins		START /STOP	1:00 30
(2). 30 seconds elapse (buzzer) Match time automatically stops			00:00 22
9. Game time expires (buzzer) Buzzer will not sound if pin is in progress			5:00 0
10. Reset game time	RESET TIMER		

- Match stopped too late:
Use timer S-1 and shot clock S-1 buttons to adjust time & pin timer difference.
- Pinned player already has waza ari: (Becomes ippon after 25 seconds)
Press the shot clock RESET button once during the pin countdown. 25 seconds will appear on the lower left display and buzzer will sound after those 25 seconds run out. Pressing RESET once more during the countdown will cancel the 25 seconds setting.
- Match time reaches 0:00 during a pin:
The match will continue without sounding a buzzer, so the pin count will not be interrupted. When the pin is broken free, press the START/STOP button on the shot clock panel. The buzzer will ring and the match will end.
- Changing the pin timer to a setting other than 30 seconds:
Press the CLEAR key and before pressing the timer START/STOP button, set the desired time using S+1 or S-1 button on the shot clock panel and press RESET.

INDOOR/OUTDOOR TIMER & SCORER

5 ROUND & BREAK COUNTDOWN TIMER

Boxing

Sequentially display designated round and remaining time for round and breaks. During breaks the colon between the minutes and seconds blinks. Also display current round number and buzzer will sound every second for countdown:

Upper display: Round timer (max=99:59)

Lower display: Round number (max=99)

Round & Break Countdown Timer				
Operation	Key Operation		Display	Buzzer
	Timer	Shot Clock		
1. Set round time (ex: 3 minutes)	Three times (M+1)		3:00 0	
2. Enter round time into memory	<input type="radio"/> RESET TIMER		0:00 0	
3. Set break time (ex: 1 minute)	(M+1)		1:00 0	
4. Enter break time into memory	<input type="radio"/> RESET TIMER		0:00 0	
5. Set number of rounds for match (ex: 3 rounds)		3 TIMES (S+1)	0:00 3	
6. Return to round time display	<input type="radio"/> RESET TIMER		3:00 1	
7. Begin match-Round number will appear in the lower left display	<input type="radio"/> START /STOP		2:59 1	(buzzer)
8. Stop round	<input type="radio"/> START /STOP		1:35 1	
9. Restart round	<input type="radio"/> START /STOP		1:34 1	(buzzer)
10. Knock-down-(chirp every second)		(START/STOP)	0:35 1	
11. Match continues-(chirp will stop)		(START/STOP)	0:28 1	
↓				
(1).Knocked down again (chirp every second)		(START/STOP)	1:20 1	
(2).10 seconds expires. Stop countdown and round timer.	<input type="radio"/> START /STOP	(START/STOP)	1:10 1	
(3).Sound match-over buzzer (buzzer)	<input type="radio"/> HORN		1:10 1	
12. First round completed (buzzer)			0:00 1	
13. Break time is displayed			0:59 1	
14. Break time ends (buzzer)			0:00 1	

Chart continues next page.....

INDOOR/OUTDOOR TIMER & SCORER

Round & Break Countdown Timer

..... Continued from previous page

15. Next round time is displayed. Round number changes to 2.			3:00 2
16. Designated number of rounds completed ( buzzer)			0:00 3
17. Begin new match.	<input type="radio"/>	RESET TIMER	3:00 1

- Round stopped too late:
Use timer M+1 and S+1 keys to adjust time. Use shot clock S-1 to adjust round.
- Round time reaches 0:00 during downcount
The match will continue without sounding the buzzer, so the downcount will not be interrupted.
- Changing round/break times:
Press CLEAR key and set as needed using steps 1 through 6 on previous page.
- In the final round, the breaktime display will disappear.







6 ELECTRONIC METRONOME:

Upper display: Rhythm times

Lower Left display: How many chirps per minute

Lower Right display: How many total short and long chirps

Electronic Metronome:

Operation	Key Operation	Display
	Rhythm	
One Loud/soft chirps		0:00 120:5
One Loud/soft chirps	Twice 	0:00 120:3
Chirps/one minute		0:00 121:3
Chirps/one minute	Twice 	0:00 119:3
Start rhythm ( chirp)	<input type="radio"/> START /STOP	0:01 119:3
Stop rhythm ( chirp)	<input type="radio"/> START /STOP	0:05 119:3
Reset rhythm times	<input type="radio"/> RESET TIMER	0:00 119:3

INDOOR/OUTDOOR TIMER & SCORER

7 PROGRAM TIMER











Timer may be programmed to consecutively countdown and display a maximum of nine time periods. This function can be used for interval training and division of time for classes and other training.

Upper display: Timer (max=99:59)

Lower left display: Repetitions (max=9 times)

Lower right display: Program number (max=9 programs)

Program Timer

Operation	Key Operation	Display
	Program Timer	
1. Set program 1 (P1) to desired time. (ex: 5 min)	 5TIMES	5:00 0 P1
2. Enter time for program 1 into memory. Change program number to 2.	 RESET TIMER	0:00 0 P2
3. Follow steps 1 & 2 above for desired number of programs(9 max).		5:00 1 P2
4. Complete program setting. Set the desired number of repetitions using the shot clock's SEC+1 key (max=99 times) and press timer RESET and START. Current program round is displayed and timer will stop, sounding buzzer.	 RESET TIMER	5:00 1 P1
5. Start Program 1 (P1) will start counting down and buzzer will sound when it reaches 0:00 P2 will subsequently start. Completion of all programs is considered one round.	 START /STOP	4:59 ( buzzer) 1 P1 0:00 ( buzzer) 1 P2 3:00 ( buzzer) 1 P3 0:00 ( buzzer) 1 P4 5:00 ( buzzer) 1 P5 ⋮ 4:59 2 P1 ⋮
6. Stop	 START /STOP	2:28 9 P1
7. Return to beginning of program	 RESET TIMER	5:00 0 P1

- Changing set times:

Press CLEAR button and follow step 1 through 4 shown above.

INDOOR/OUTDOOR TIMER & SCORER

8 CLOCK, ALARM

Displays time in 12-hour format normally, Will change to 24-hour display when stopped for editing.

Upper display: Hours: Minutes

Lower right display: Seconds

This clock function with wireless shot clock control function.

Operation	Key Operation		Scoreboard front display	Wireless shot clock display
	Clock	Shot Clock		
1. Stop clock to adjust time			0:00 00	0:00 ↑ FLASHING
2. Set hours using M+1 or M-1 key Set minutes using S+1 or S-1 key Set seconds using S+1 or S-1 key on shot clock panel	M+1 S+1	S+1	9:35 20	9:35 ↑ NON FLASHING
3. Clock	○ START /STOP		9:35 21	9:35
4. Alarm	▶ SET		12:00 AL OFF	9:35
5. Alarm on/off	◀ SET		12:00 AL ON	9:35
6. Alarm time setting.	M+1		13:00 AL ON	9:35
	S+1		13:59 AL ON	9:35
7. Return to clock	▶ SET		9:36 45	9:36

- When the current clock reaches the Alarm time, a 5 second alarm will be activated.
- Current time and alarm will not be affected by changing game type, but if power is turned off, current time will be lost.

INDOOR/OUTDOOR TIMER & SCORER

4. SPECIFICATIONS

- * INPUT POWER: AC90V~240V, 50Hz/60Hz.
- * CONSUMING POWER:<25 Watts
- * VIEWING DISTANCE:>165 Feet
- * TIME ACCURACY: Within 0.5 sec per day.
- * DIMENSION: 23.6"(Width)* 15.6"(Height)* 10.2"(Depth)
- * WEIGHT: 14.33 Lbs (Approx.)
- * FCC TEST APPROVAL
THIS DEVICE HAS BEEN TESTED AND FOUND TO COMPLY WITH THE LIMITS FOR CLASS B DIGITAL DEVICE, PURSUANT TO PART 15 OF THE FCC RULE.
- * AC 90 TO 240V FULL RANGE POWER INPUT, CONSUMING POWER<25 WATTS.

Cautions

- For portable indoor/outdoor use only. Avoid outdoor storage.
- Keep away from high temperatures, humidity, dew, water and direct sunlight.
- Always disconnect power cord and other cables by holding plug.
- Clean with damp cloth only.

